

CONTROL BASIC **ASTRALPOOL**

INSTRUCTIONS MANUAL **EN**

HANDBUCH **DE**

MANUAL DE INSTALACION **ES**

MANUEL D'INSTALLATION **FR**

MANUALE D'INSTALLAZIONE **IT**

CONTROL BASIC **ASTRALPOOL**

PACK CONTENTS

- A) pH / REDOX control device
- B) PVC Crystal 4x6 with suction device (2 m)
- C) Polyethylene delivery hose (3m)
- D) Attachment screw ($\phi=6$ mm)
- E) Foot filter (PVC riser)
- F) FPM duckbill valve (3/8" GAS)

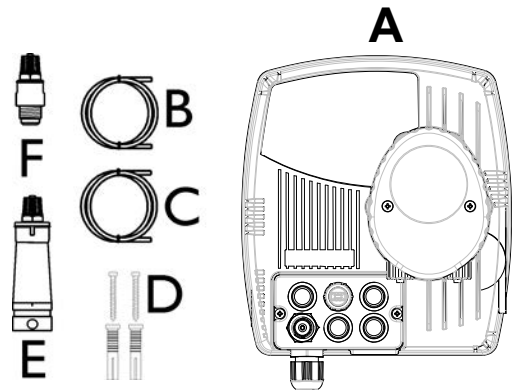

TECHNICAL SPECIFICATIONS

Dimensions (H – W – L)	191x155x123 mm
Weight	1 kg
Power supply	230 VAC
Consumption	6 W
Pump flow rate	1,5 l/h
Maximum back-pressure	1,5 bar
Pump state	Pause - Supply
Measure scale	0 ÷ 14.0 pH; Redox 0 ÷ +1000 mV
Device precision	± 0,1 pH; ±10 mV
Device accuracy	± 0,02 pH; ±2 mV
Electrode regulation	Automatic

Wall Mounting Setup

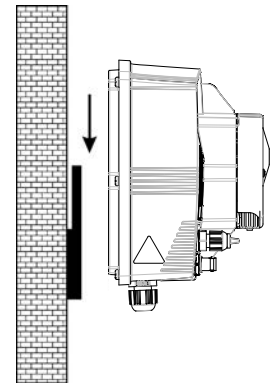

ATTENZIONE / WARNING / ATTENTION / ACHTUNG

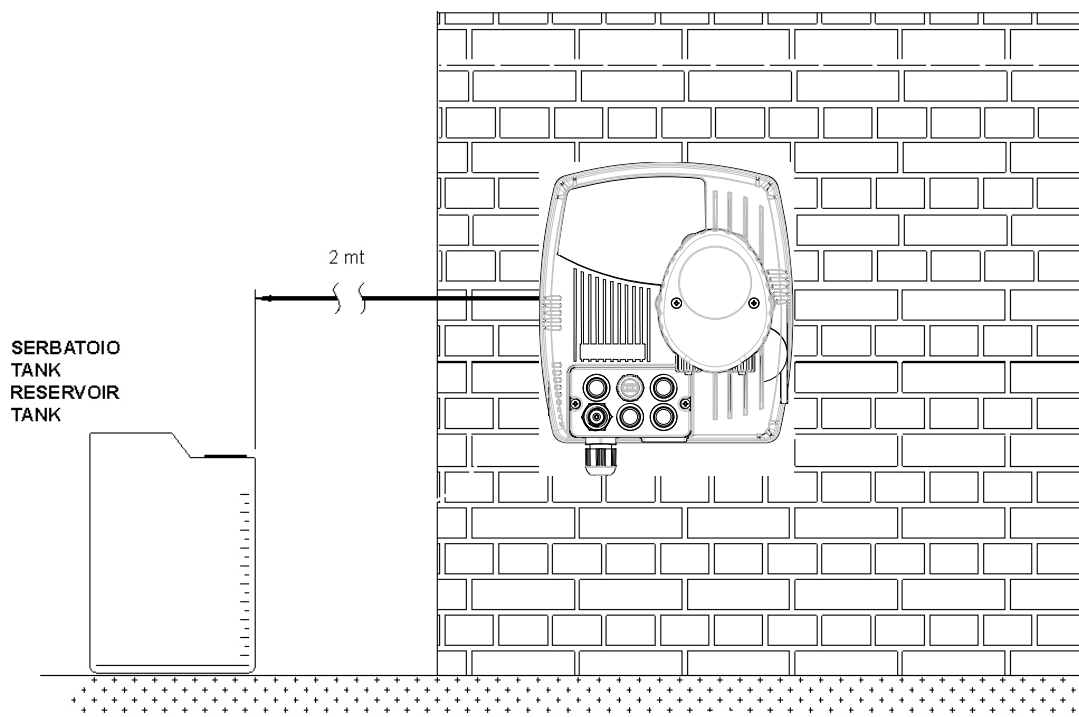





INSTRUCTION SETTING

Functions:

CALIBRATION



- Press  for 3 Seconds
- Sequence Standard calibration buffer solution 7 and 4 pH or Redox 465mV

SET POINT



- Press: 
- hold down  and change the value with key 
 - **7.4ph**
 - **750mV**
- Press   (together) for 5 Seconds and run Program Setup

PROGRAM



Press  to set the following Item:

- **Configuration Pump**
 - select  pH or Redox
- **Language**
 - With the button  It's possible to have 5 language EN, IT, ES, DE, FR
- **Flow**
 - Select with the button 
 - It's possible to enable(ON) or disable (OFF) signal input flow (high voltage) connected in parallel to the recirculation pump.

SETPOINT 7.4ph or 750mV

- Select with the button  and set with 
- It's possible to adjust from 0 to 14 pH value and 0 to 1000 mV for Redox.



SETPOINT TYPE ACID

- Select with the button  and set with 
- It's possible to adjust Acid or Alkaline dosing and High or Low for Redox



OFA TIME OFF

- Select with the button  and set with 
- It's possible to adjust OFA time in minutes

CALIBRATION 7/4pH or 465mV

- Select with the button  and set with 
- It's possible to select 2 points 7 and 4 pH, 1 point only 7pH or function disable; we have 465 mV for the redox function or disabled

MAN TEMPERATURE 25°C (pH measure only)

- Select with the button  and set with 
- Set the temperature manually (pH measure only)
- Save and escape Program setup with ESC key.

EXIT SAVE

- Select with the button  and set with  Save or Not Save

PRIMING







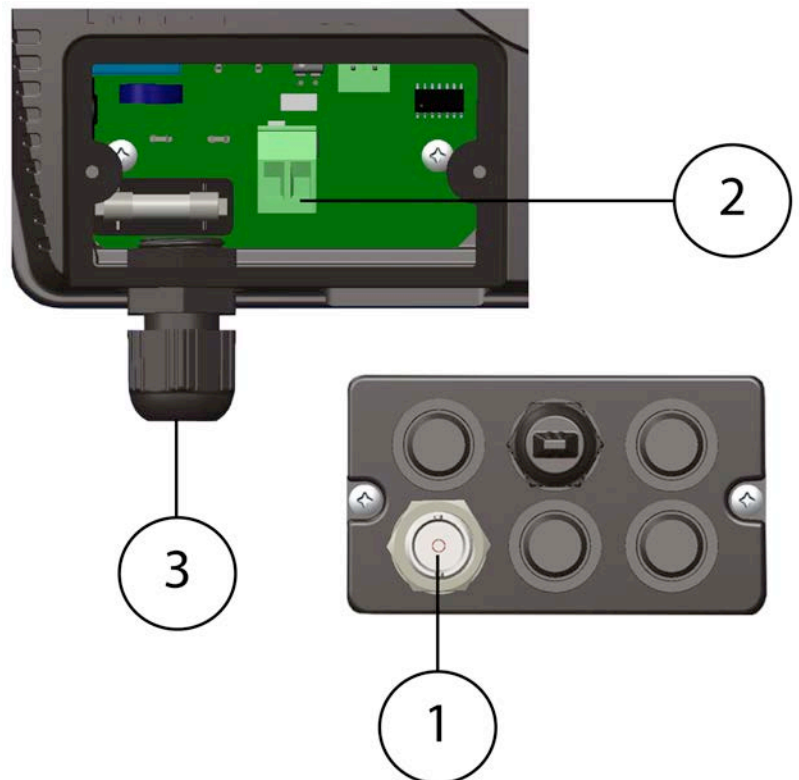

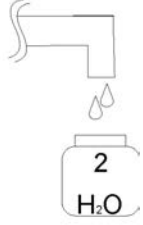

- Priming Pump Keep Press  for 3 seconds

Wire Connection:

- 1) Input pH or Redox Probe
- 2) Input Flow Rate (High Voltage 230 Vac)
- 3) Power Supply 230 Vac 50Hz/60Hz

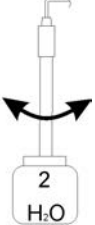

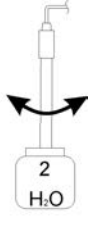
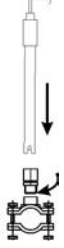





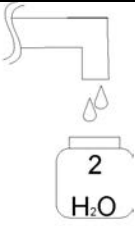

pH Probe Calibration

 1	 2	 3 Wash
 Keep probe into Buffer solution 4	Calibration Press  for 3 Seconds 5	7pH Press CAL  Calibration During 1 minutes Wait 60s 6
7pH Quality 100% Quality Probe 7	 8 Wash	 9 Keep probe into Buffer solution
4pH Press CAL  Calibration During 1 minutes Wait 60s 10	4pH Quality 100% Quality Probe 11	 12 Wash
 13	Press  to save and exit 14	Normal Status 15

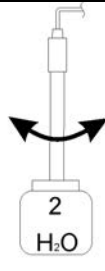
Note:

If you have setting Calibration = 7 pH the function has 1 point calibrate only 7 pH buffer solution.

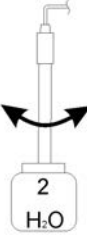
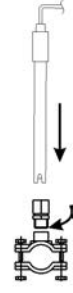
Redox Probe Calibration

 <p>1</p>	 <p>2</p>	 <p>3 Wash</p>
 <p>Keep probe into Buffer solution</p> <p>4</p>	<p>5</p> <p style="text-align: center;">Calibration</p> <p style="text-align: center;">Press  for 3 Seconds</p>	<p>6</p> <p style="text-align: center;">465mV Press CAL</p> <p style="text-align: center;"></p> <p style="text-align: center;">Calibration During 1 minutes</p> <p style="text-align: center;">Wait 60s</p>
<p>7</p> <p style="text-align: center;">465mv Quality 100%</p> <p style="text-align: center;">Quality Probe</p>	 <p>8 Wash</p>	 <p>9</p>
<p>10</p> <p style="text-align: center;">Press  for 3 Seconds</p>	<p>11</p> <p style="text-align: center;">Normal Status</p>	

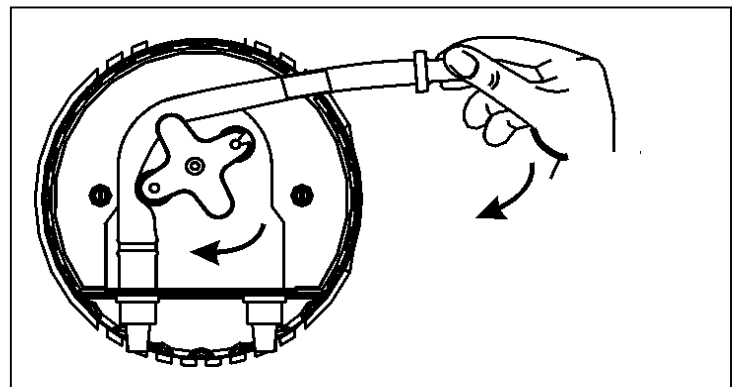
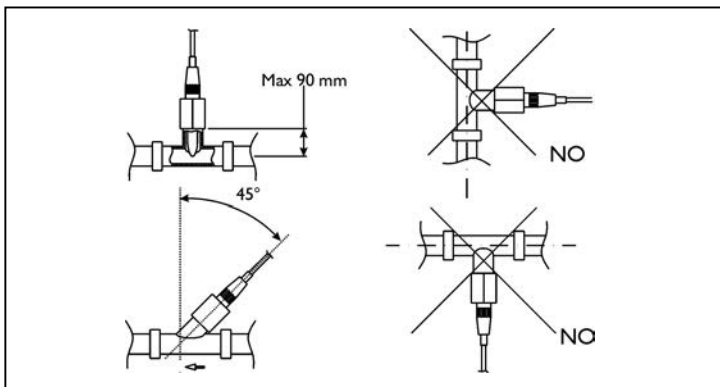
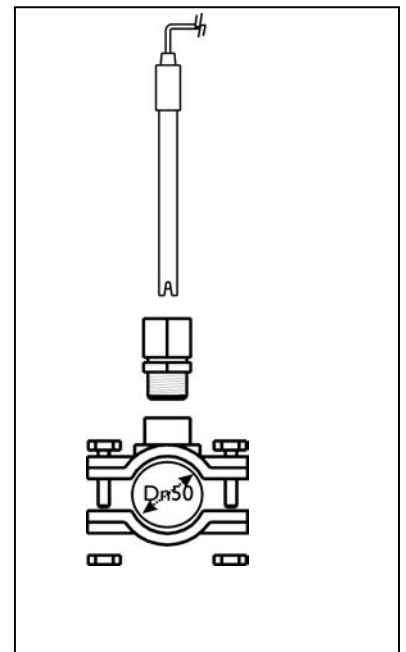
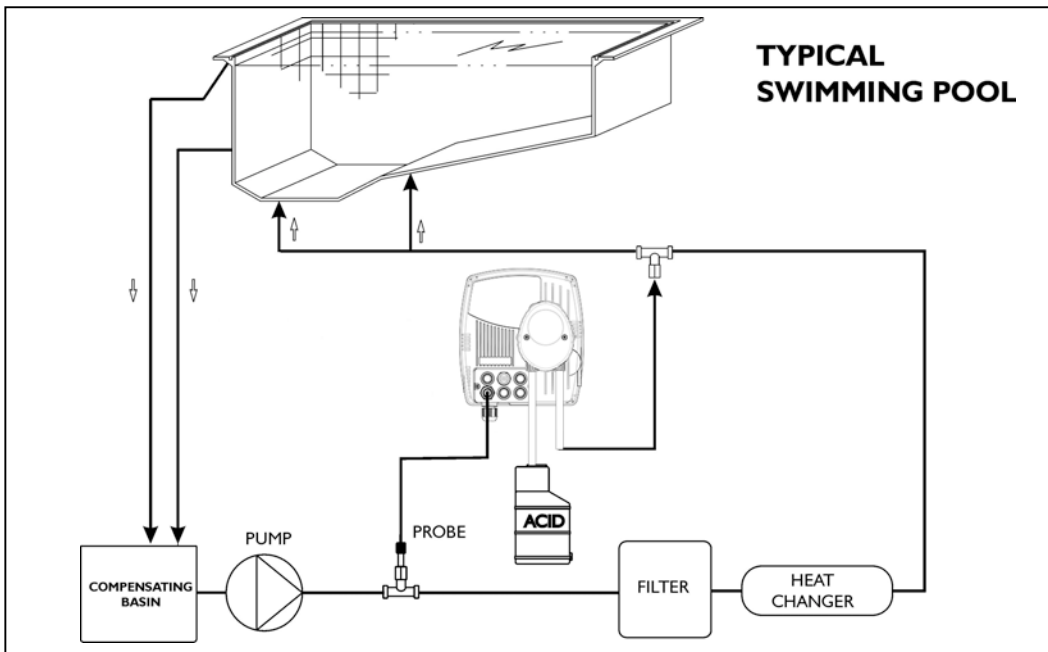







Alarm	Display	Actions to do
OFA First Alarm (time >70%)	OFA Alarm	- Push Enter Key to reset
OFA Second Alarm (time =100%)	OFA STOP	- Push Enter Key to reset
Flow Rate	Flow	- Restore Flow Rate
System Error	Parameter Error	- Press Enter Key to replace Default parameter - Destroy Unit
Calibration Funciont	Error 7 ph Error 4 ph Error 465 mV	- Restore Probe or Buffer solution and repeat calibration function

Default parameters:

- Language = **UK**
- Set Point value= **7,4 pH; 750mV (Rx)**
- Dosing Method = **Acid; Low (Rx)**
- Time OFA = **OFF**
- Calibration = **7/4 (2 point); 465mV (Rx)**
- Flow Input= **OFF**

To restore Default parameters run Following steps:

- Power off Pool Basic unit
- Keep pressing both buttons simultaneously  
- and  To turn on the system Basic.
- The system will show **Default No**
- Press  for **Default Yes**
- Press   to restore Default parameters.

CONTROL BASIC **ASTRALPOOL**

VERPACKUNGSINHALT

- A) pH / REDOX Kontrollsystem
- B) PVC-Schlauch Crystal 4x6 (2 m)
- C) Polyethylen-Schlauch (3 m)
- D) Schrauben mit Dübeln ($\phi = 6$ mm)
- E) Fußfilter (PVC)
- F) Rückschlagventil aus FPM (3/8" GAS)

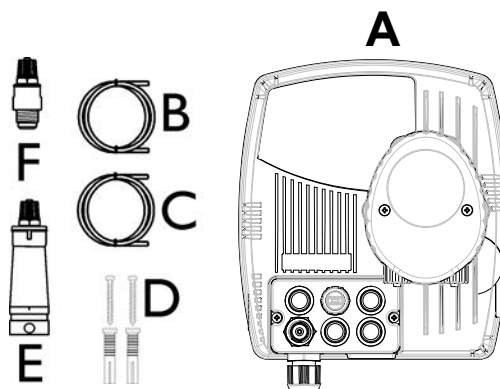

TECHNISCHE DATEN

Abmessungen (H - B - T)	191x155x123 mm
Gewicht	1 kg
Spannungsversorgung	230 VAC
Verbrauch	6 W
Förderleistung der Pumpe	1,5 l/Std.
Max. Gegendruck	1,5 bar
Pumpenstatus	Pause - Betrieb
Messskala	0 ÷ 14.0 pH; Redox 0 ÷ +1000mV
Messgenauigkeit	$\pm 0,1$ pH; ± 10 mV
Genauigkeit Maß	$\pm 0,02$ pH; ± 2 mV
Kalibrierung der Elektrode	Automatisch

Wandmontage

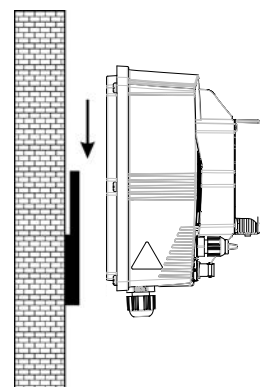

ATTENZIONE / WARNING / ATTENTION / ACHTUNG

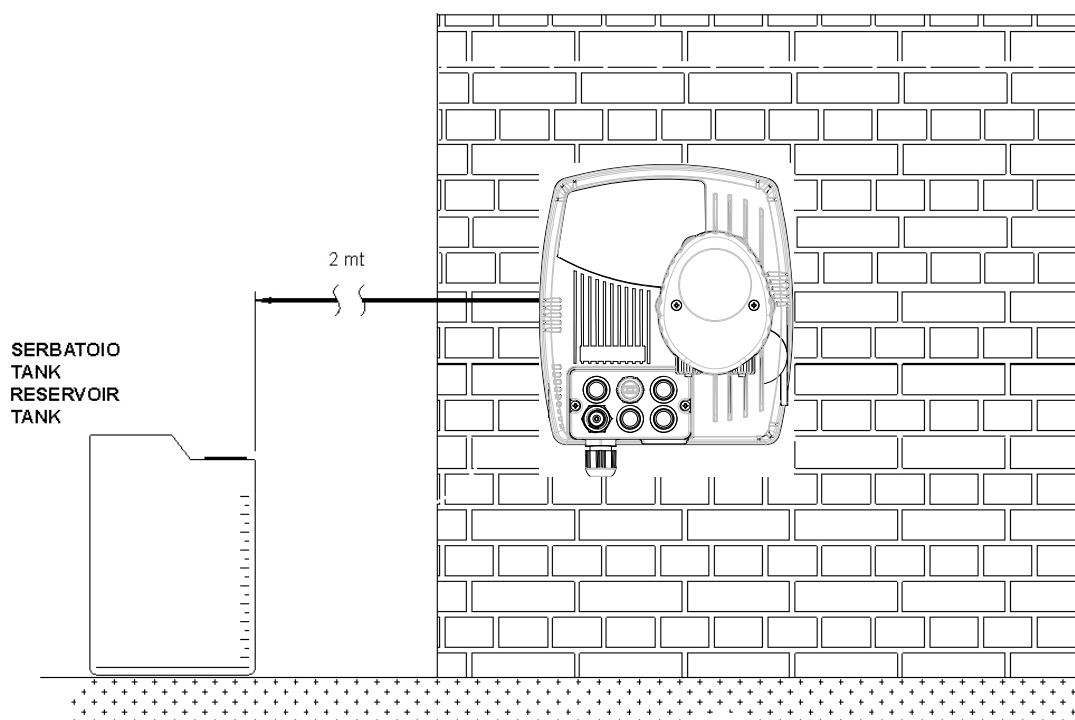





EINSTELLUNGEN

Funktion:

KALIBRIERUNG

- 3 Sekunden lang die Taste  drücken:
- Standardabfolge der Kalibrierung für Pufferlösung mit pH-Wert 7 und 4 oder 465mV für Redox



SET POINT

- Taste  drücken:
- Die Taste  gedrückt halten und den Wert über die Tasten  verändern.
 - **7.4ph**
 - **750mV**
- Die Tasten   (zusammen) 5 Sekunden lang gedrückt halten, um in das Konfigurationsmenü zu gelangen:



PARAMETER





drücken, um die folgenden Punkte einzustellen:

- **Konfig Pumpe**
 - Wählen  pH oder Redox
- **Sprache**
 - Mit der Schaltfläche  Es können 5 Sprachen eingestellt werden EN, IT, ES, DE, FR
- **Fluss**
 - Wählen Sie mit der Taste 
 - Der Durchflusseingang (Hochspannung), der parallel zur Rückförpumppe angeschlossen ist, kann aktiviert (ON) oder deaktiviert (OFF) werden.



SOLLWERT 7.4ph oder 750mV

- Über die Taste  auswählen und über  einstellen
- Der Wert kann zwischen 0 und 14 pH oder für Redox-messungen zwischen 0 und +1000 mV verändert werden.



SOLLWERT TYP SAURE

- Über die Taste  auswählen und über  einstellen
- Kann zur Dosierung einer alkalischen oder einer sauren Lösung oder für Redox auf High oder Low gestellt werden.



OFA ZEIT OFF

- Über die Taste  auswählen und über  einstellen
- Hier kann die OFA-Zeit (Zeit der Überdosierung in Minuten) verändert werden.

KALIBRATION 7/4pH oder 465mV

- Über die Taste  auswählen und über  einstellen
- Die Abfolge der Kalibrierung kann auf 2 Punkte (7 und 4 pH), oder nur auf 1 Punkt (nur 7 pH) eingestellt oder die Funktion deaktiviert werden; für Redox haben wir 465 mV oder Funktion deaktiviert.

TEMPERATUR MAN 25°C (nur bei der pH-Messung)

- Über die Taste  auswählen und über  einstellen
- Der Temperaturwert kann manuell eingegeben werden (nur bei der pH-Messung)
- Speichern und das Programmmenü über die Taste ESC verlassen.

VERLASSEN SICHERN

- Über die Taste  auswählen und über  einstellen sparen oder nicht sparen

ANSAUGUNG







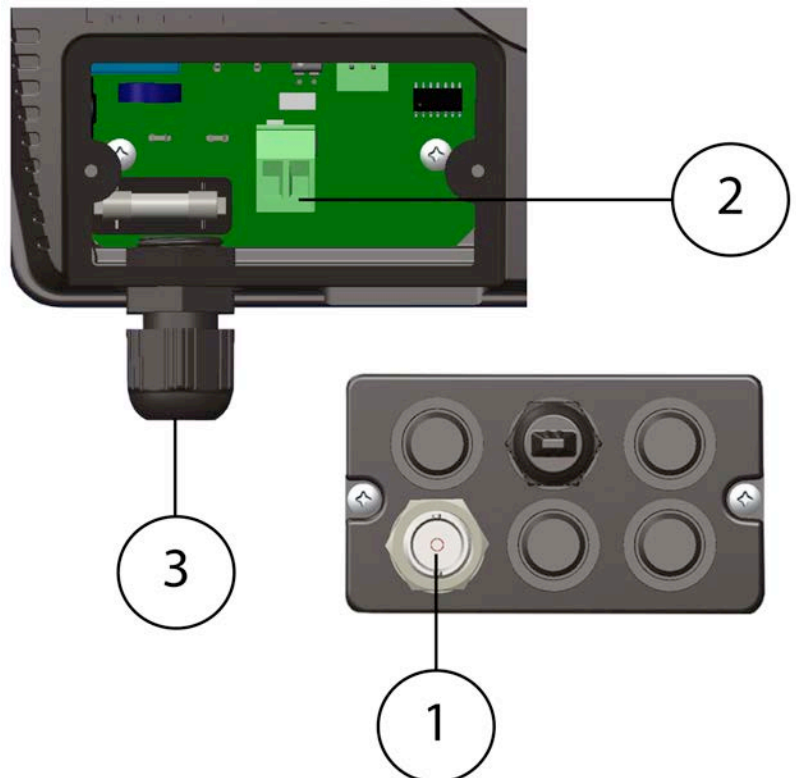

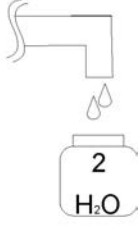

- Für die Funktion manuelles Ansaugen die Taste  3 Sekunden lang gedrückt halten

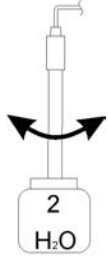
Anschluss der Kabel:

- 1) Eingang pH- oder Redoxfühler
- 2) Durchflusseingang, Durchfluss Rückförmpumpe (elektrisches Signal 230 Vac)
- 3) Stromversorgung 230 Vac 50Hz / 60Hz.

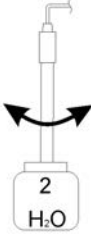

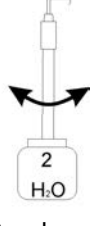
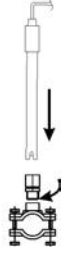





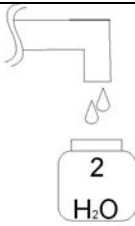

Kalibrierung der pH-Sonde

 <p>1</p>	 <p>2</p>	 <p>Die Sonde spülen</p> <p>3</p>
 <p>Die Sonde in die Pufferlösung halten</p> <p>4</p>	<p>Kalibration</p>  <p>Die Taste  3 Sekunden lang drücken</p> <p>5</p>	<p>7pH CAL Drucken</p>  <p>Die Kalibrierung dauert eine Minute 60s Pause</p> <p>6</p>
<p>7pH Qualität 100%</p> <p>Qualität der Sonde</p> <p>7</p>	 <p>Die Sonde spülen</p> <p>8</p>	 <p>Die Sonde in die Pufferlösung halten</p> <p>9</p>
<p>4pH CAL drücken</p>  <p>Die Kalibrierung dauert eine Minute 60s Pause</p> <p>10</p>	<p>4pH Qualität 100%</p> <p>Qualität der Sonde</p> <p>11</p>	 <p>Die Sonde spülen</p> <p>12</p>
 <p>13</p>	<p>Drücken Sie die Taste  zum Beenden und speichern Sie die Daten</p> <p>14</p>	<p>Normaler Mess- und Kontrollstatus</p> <p>15</p>

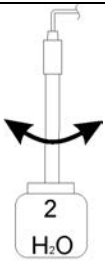
Hinweis:

Wenn wir die Funktion Kalibrierung = 7 pH einstellen, führt das System die Kalibrierung nur für den Punkt 7 pH aus.

Kalibrierung der Redox-Sonde

 <p>2 H₂O</p>		 <p>2 H₂O</p> <p>Die Sonde spülen</p>
<p>1</p>	<p>2</p>	<p>3</p>
 <p>465 mV</p> <p>Die Sonde in die Pufferlösung halten</p>	<p>Kalibration</p> <p>Die Taste  Sekunden lang drücken</p>	<p>465mV CAL Drucken</p> <p></p> <p>Die Kalibrierung dauert eine Minute</p> <p>60s Pause</p>
<p>4</p>	<p>5</p>	<p>6</p>
<p>465mV Qualität 100%</p> <p>Qualität der Sonde</p>	 <p>2 H₂O</p> <p>Die Sonde spülen</p>	
<p>7</p>	<p>8</p>	<p>9</p>
<p>Die Taste  3 Sekunden lang drücken</p>	<p>Normaler Mess- und Kontrollstatus</p>	
<p>10</p>	<p>11</p>	

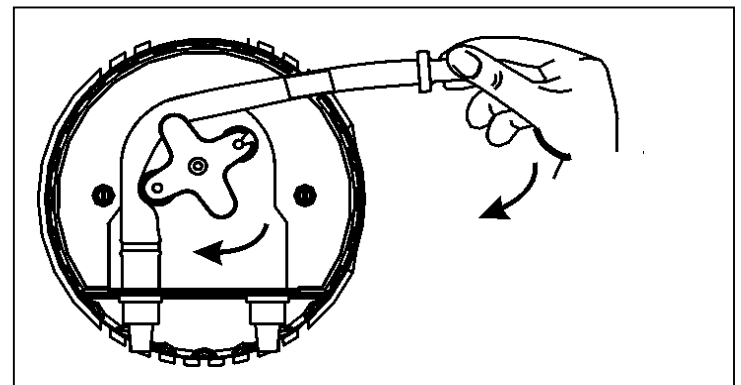
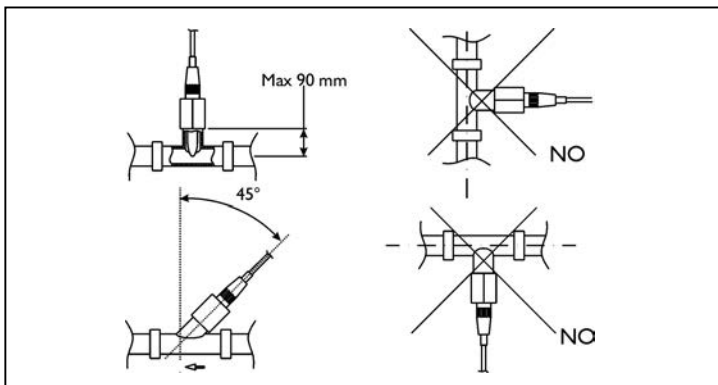
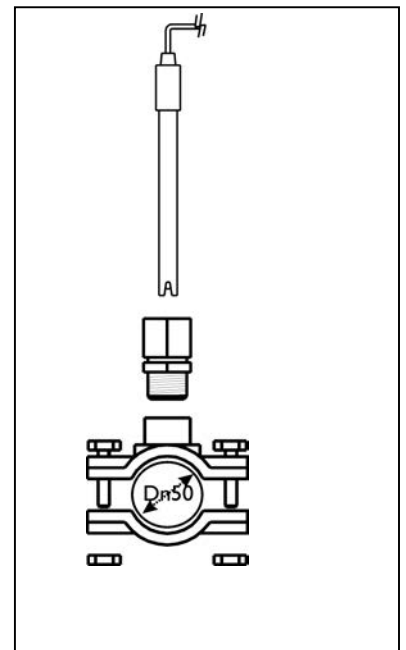
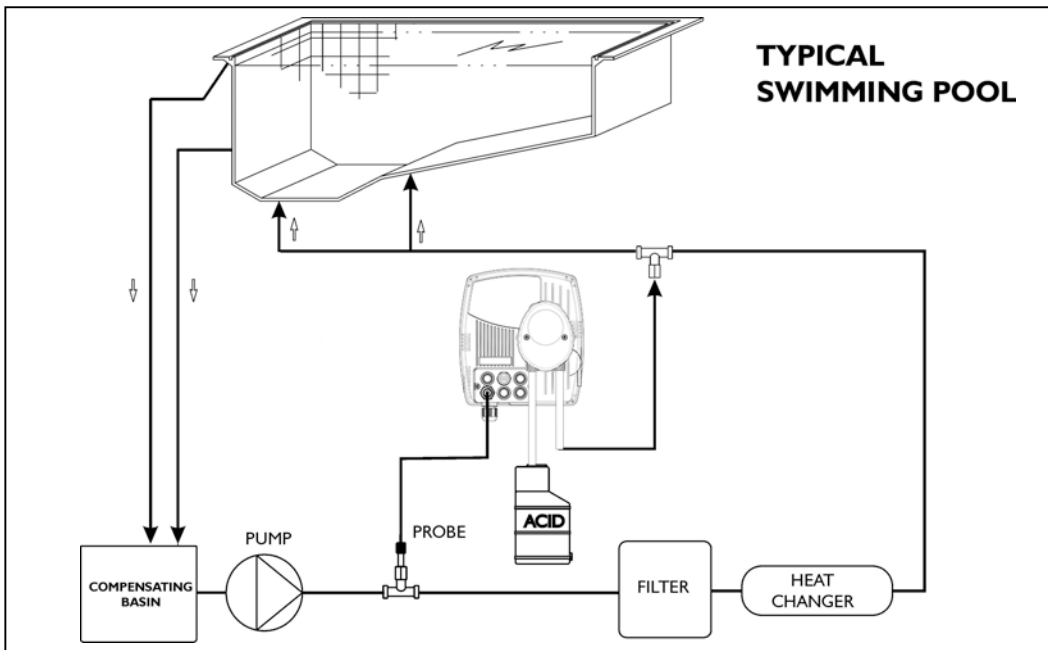

Alarm	Display	Was ist zu tun
Erster OFA-Alarm (Zeit >70%)	Alarm OFA	- Die Taste Enter drücken, um den alarm zu beseitigen
Zweiter OFA-Alarm (Zeit=100%)	STOP OFA	- Die Taste Enter drücken, um den Alarm zu beseitigen
Wasserdurchfluss (Rückführungspumpe ausgeschaltet)	Fluss	- Wasserrückführungspumpe wieder einschalten.
Systemfehler	Parameter Error	- Enter drücken, um die Werkseinstellungen wieder herzustellen - System kaputt
Kalibrierfunktion	Fehler 7 ph Fehler 4 ph Fehler 465 mv	- Die Sonde oder die Pufferlösung austauschen und die Kalibrierung wiederholen.

Werksparemeter:

- Sprache = **UK (Englisch)**
- SetPoint Wert = **7,4 pH; 750mV (Rx)**
- Dosiermethode = **Säure; Niedrig (Rx)**
- OFA-Zeit = **OFF**
- Kalibrierung = **7/4 (2 Punkte); 465mV**
- Durchflusseingang = **OFF**

Um die Werkseinstellungen (Default) wieder herzustellen, wie folgt vorgehen:

- Das Basic-System ausschalten
- Die Taste **CAL** und **ENTER** gedrückt halten und das Basic-System einschalten.
- Das System zeigt folgendes an: **Default No**
- Drücken Sie die Taste **ENTER** **Default Yes**
- Drücken Sie die Taste **CAL** und **ENTER** um die Parameter wieder herzustellen.

CONTROL BASIC **ASTRALPOOL**

CONTENIDO DE LA CAJA

- A) Controlador pH / REDOX
- B) Tubo PVC cristal 4x6 mm para aspiración (2 m)
- C) Tubo PEAD 4x6 m para impulsión (3m)
- D) Tornillos ($\phi=6$ mm)
- E) Válvula de pie (PVC)
- F) Válvula de inyección (labio) FPM (3/8" GAS)

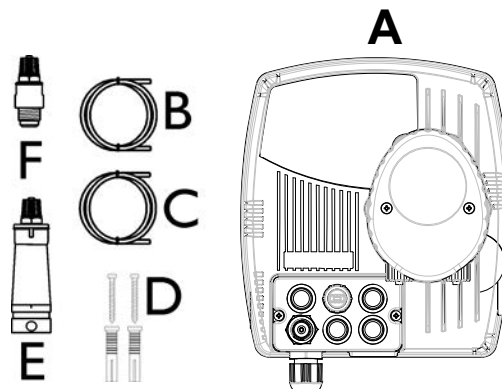

DIMENSIONES

Dimensiones (H – W – L)	191x155x123 mm
Peso	1 kg
Alimentación	230 VAC
Consumo	6 W
Caudal de la bomba	1,5 l/h
Contrapresion maxima	1,5 bar
Estado de la bomba	Pausa - Alimentación
Rango medida	0 ÷ 14.0 pH; Redox 0 ÷ +1000 mV
Rango control	$\pm 0,1$ pH; ± 10 mV
Precision	$\pm 0,02$ pH; ± 2 mV
Regulación electrodo	Automatic

Montaje Pared

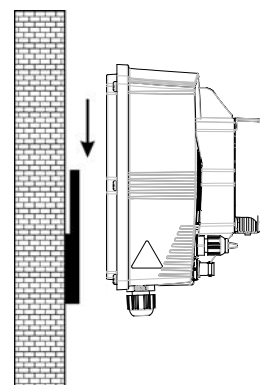

ATTENZIONE / WARNING / ATTENTION / ACHTUNG

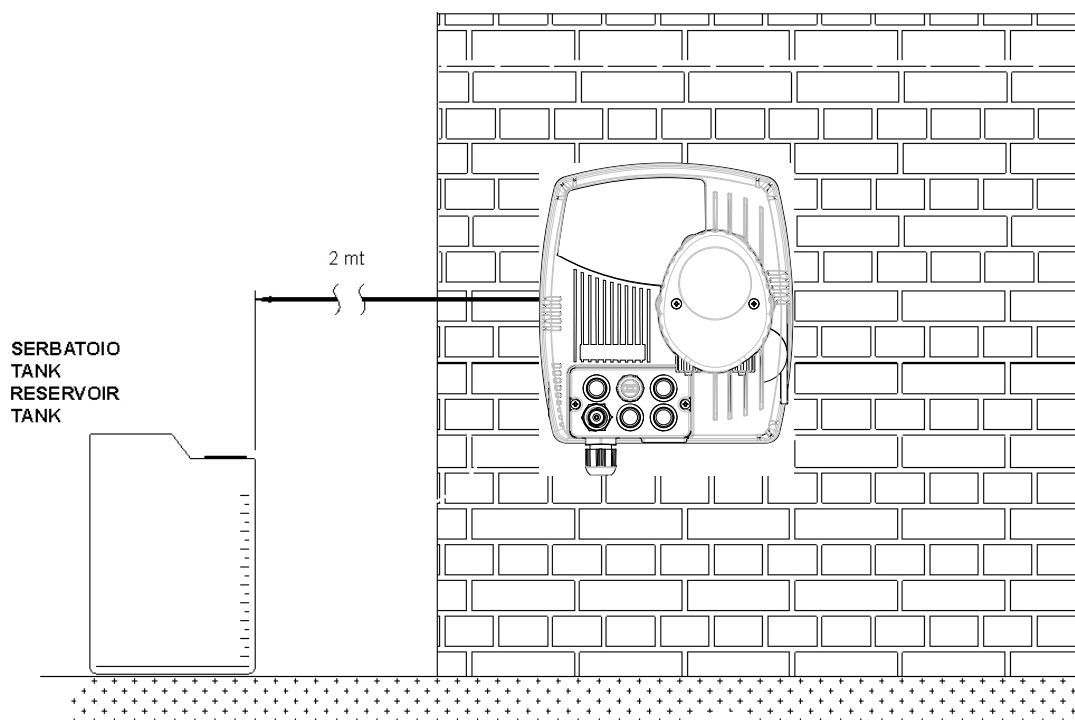





INSTRUCCIONES

Funciones:

CALIBRACIÓN



- Presionar pulsador  durante 3 segundos
- Secuencia Secuencia de calibración estándar para la solución tampón pH 7 y 4 o 465mV para Redox

SET POINT



- Presionar pulsador 
- Mantener pulsado  y cambie el valor con la tecla 
 - **7.4ph**
 - **750mV**
- Presione las teclas   (Juntos) durante 5 segundos y ejecutar el menú de configuración

PROGRAM CONFIGURATION



Presionar  para las siguientes instrucciones:

- **Configuración de Bomba**
 - Seleccionar  pH o Redox
- **Idioma**
 - Con el botón  es posible elegir entre 5 idiomas EN, IT, SP, DE, FR
- **Caudal**
 - Seleccionar mediante el botón 
 - Es posible conectar (ON) o desconectar (OFF) la entrada de señal



SETPOINT 7.4ph o 750mV

- Seleccionar mediante el botón  y establecer con 
- Es posible ajustar desde 0 a 14 el valor de pH y 0 to 1000 mV para Redox



TIPO SETPOINT ACIDO

- Seleccionar mediante el botón  y establecer con 
- Es posible ajustar Acido (pH -) o Alcalino (pH +) y Alto (dosificacion oxidante) o Bajo (dosificacion reductor) para Redox



OFA OFF

- Seleccionar mediante el botón  y establecer con 
- Es posible ajustar el tiempo de OFA en minutos

CALIBRACIÓN 7/4pH o 465mV

- Seleccionar mediante el botón  y establecer con 
- Es posible seleccionar 2 puntos pH7 y pH 4 , 1 punto solo pH7 o función desconectada; para Redox solo es posible desconectar la función.

TEMPERATURA MAN 25°C (Sólo para la medición de pH)

- Seleccionar mediante el botón  y establecer con 
- Establezca el valor del manual de la temperatura (esta función solo esta disponible para la medida de pH)
- Para salir y escapar del menú de programación pulsar la tecla ESC.

SR LIR

- Seleccionar mediante el botón  y establecer con  Salvar o No Salvar

PRIMING







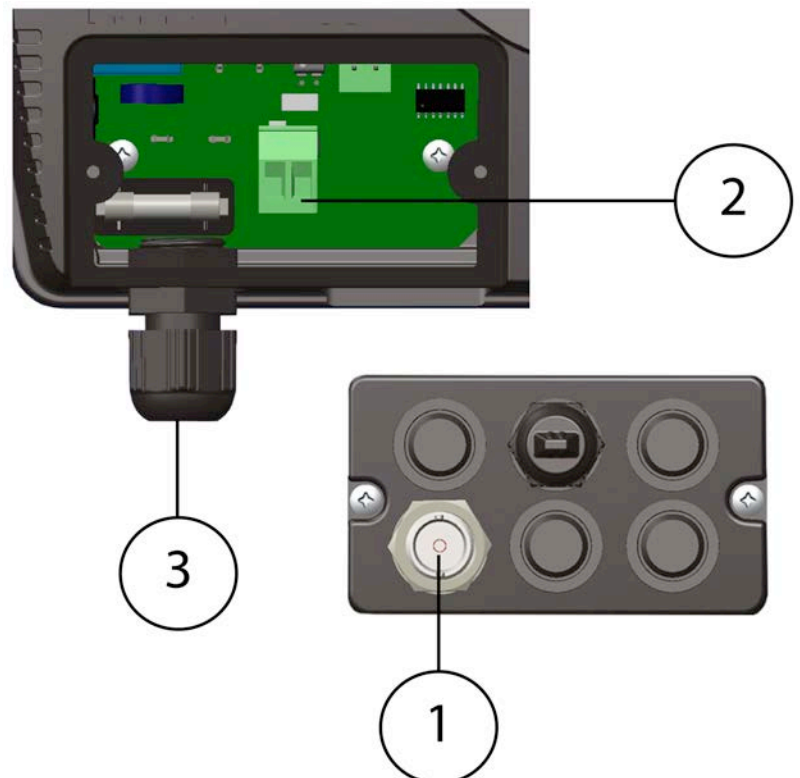

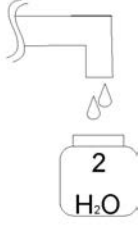

- Para cebar (cargar) la bomba dosificadora presionar el pulsador  durante 3 segundos.

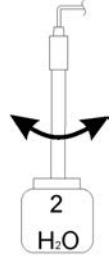
Connessione Cavi:

- 1) Entrada sonda pH or Redox
- 2) Entrada Flujo, Flujo bomba de recirculación (señal eléctrico 230 Vac)
- 3) Alimentación 230 Vac 50Hz / 60Hz.

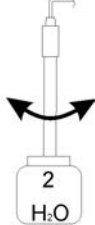

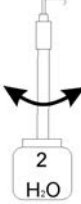
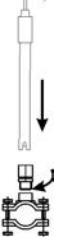





Calibración electrodo de pH

 1	 2	 3 Lavar
 4 Poner en la solución pH 7	Calibración  Pulsar  durante 3 segundos	7pH Press CAL  Duración de la calibración 1 min. Espera 60s
7 pH7 Calidad 100% Calidad electrodo	 8 Lavar	 9 Poner en la solución pH 4
4pH Press CAL  Duración de la calibración 1 min. Espera 60s	4pH Calidad 100% Calidad electrodo	 12 Lavar
 13	Presionar  para salvar y salir	15 Estado Normal

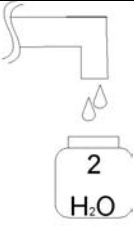
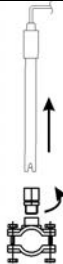
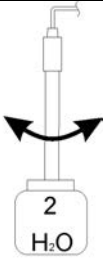
Nota:

Si en la configuración en el menú de calibración eligió 1 punto, solo precisará solución patrón pH7.

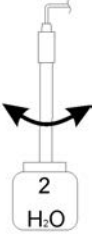
Calibración electrodo de Redox

 1	 2	 3 Lavar
 Keep probe into Buffer solution 4	Calibración Pulsar  durante 3 segundos 5	465mv Press CAL  Duración de la calibración 1 min. Espere 60s 6
465mv Calidad 100% Calidad electrodo 7	 8 Lavar	 9
Presionar  durante 3 segundos 10	Estado Normal 11	

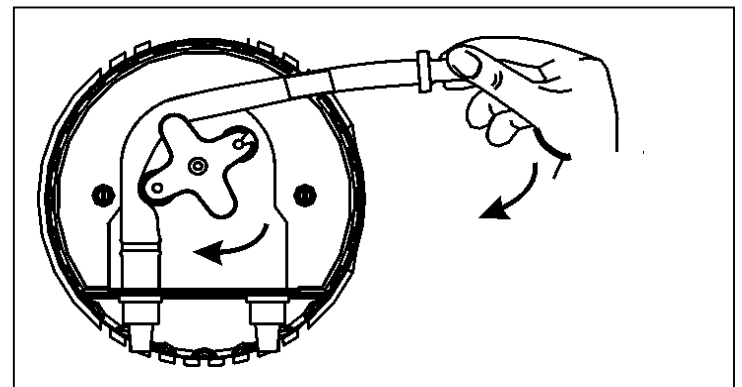
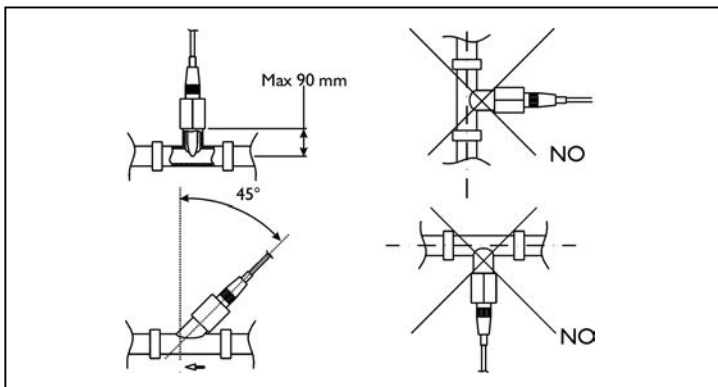
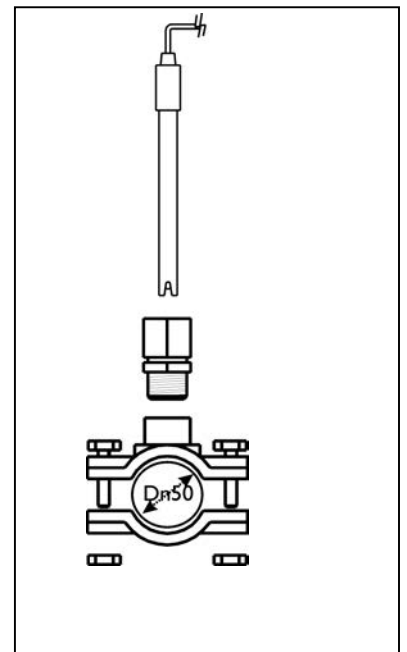
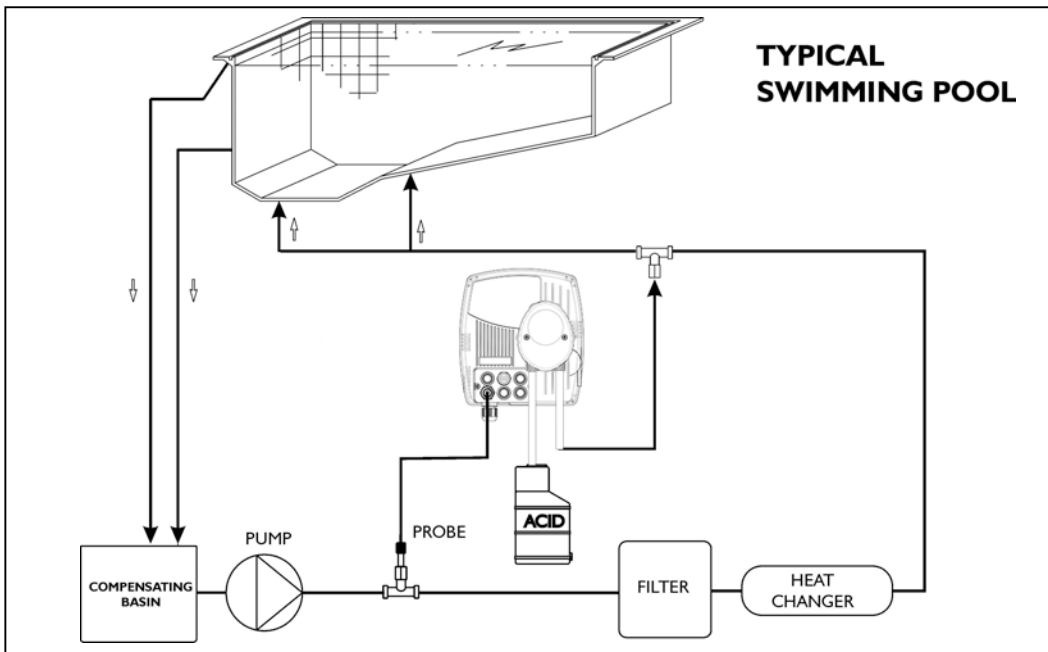





Alarma	Display	Acciones a hacer
OFA Primera alarma (tiempo >70%)	OFA alarm	- Pulsar Enter para aceptar.
OFA Segunda alarma (tiempo =100%)	OFA stop	- Pulsar Enter para acepta
Caudal	Caudal	- Restaurar el caudal o recirculación.
Error de sistema	Error de Parámetro	- Presione Enter para sustituir el valor defectuoso - Equipo averiado. - Posible obstrucción de la inyección
Función calibración	Error 7ph Error 4ph Error 465 mV	- Sustituir el electrodo o solución patrón y repetir la calibración.

Parámetros de fabrica:

- Idioma = **UK**
- Set Point= **7,4 pH**
- Tipo de dosificación = **Acid**
- Tiempo OFA = **OFF**
- Calibración = **7/4 points)**
- Entrada de caudal **OFF**

Restaurar valores de fabrica:

- Desconectar la unidad electricamente
- Mantenga pulsado los dos botones  y  simultáneamente para encender el sistema Basic.
- En el display parpadea **Default No**
- Presionar el pulsador  para **Default Yes**
- Presionar el pulsador  para restaurar los valores de fabrica

CONTROL BASIC **ASTRALPOOL**

CONTENU DE L'EMBALLAGE

- A) Système de contrôle de pH / REDOX
- B) Tuyau PVC Crystal 4x6 (2 mètres)
- C) Tuyau Polyéthylène (3 mètres)
- D) Vis avec chevilles ($\phi = 6$ mm)
- E) Filtre d'aspiration (PVC)
- F) Clapet de non-retour en Viton FPM (3/8" GAZ)

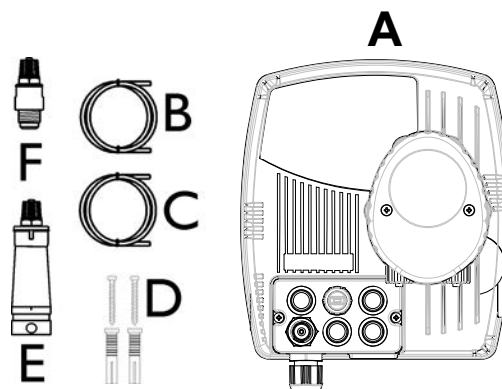

SPECIFICATIONS TECHNIQUES

Dimensions (H – L – P)	191x155x123 mm
Poids	1 kg
Alimentation	230 VAC
Consommation	6 W
Débit de la pompe	1,5 l/h
Contre-pression maximale	1,5 bar
État de la pompe	Pause - Activation
Échelle de mesure	0 ÷ 14,0 pH ou Redox 0 ÷ +1000 mV
Précision de la mesure	$\pm 0,1$ pH; ± 10 mV
Mesure d'exactitude	$\pm 0,02$ pH; ± 2 mV
Étalonnage de l'électrode	Automatique

Fixation murale

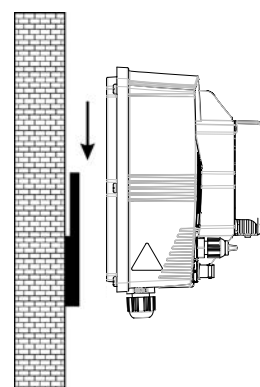

ATTENZIONE / WARNING / ATTENTION / ACHTUNG

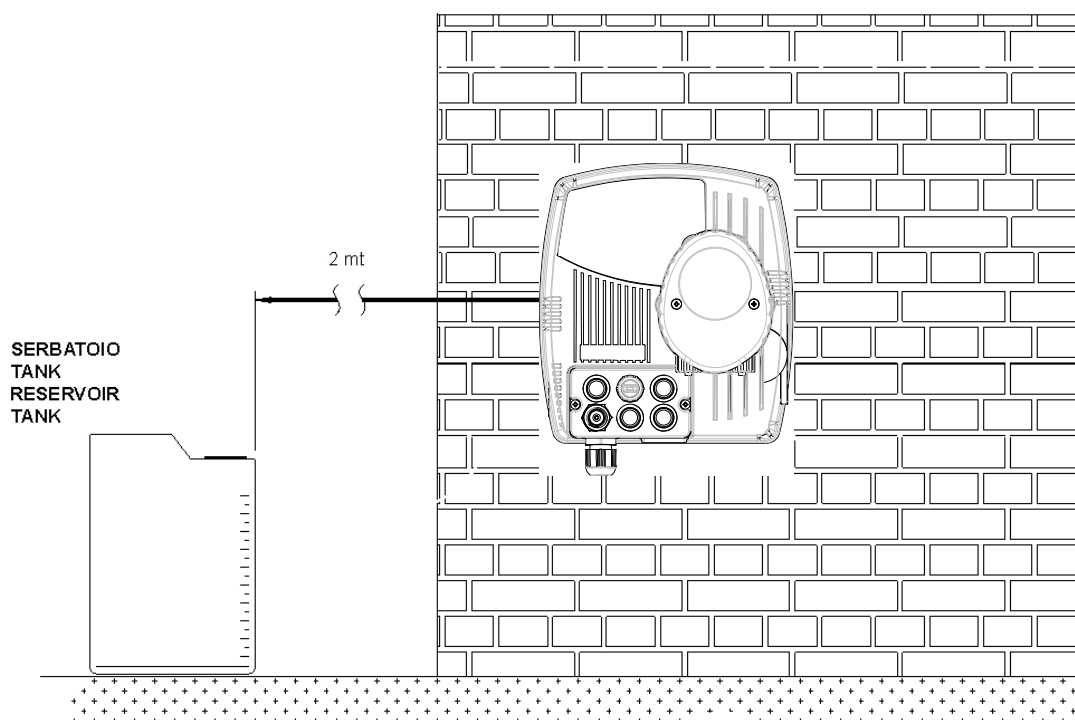

REGLAGES

Function:

CALIBRAGE



- Appuyer sur la touche  pendant 3 secondes
- Séquence Standard étalonnage pour la solution tampon 7 et 4 pH ou 465mV pour Rédox

CONSIGNE



- Appuyer sur la touche 
- Maintenir la touche  et modifier la valeur 
 - **7.4ph**
 - **750mV**
- Appuyer sur les touches   (en même temps) pendant 5 secondes pour activer le menu configuration

PROGRAMME CONFIGURATION



Appuyer sur  pour programmer les paramètres ci-après:

- **Function**
 - Sélectionner  pH ou Rédox
- **Langue**
 - Avec le bouton  On peut régler 5 différentes langues EN, IT, ES, DE, FR
- **Debit**
 - Sélectionner 
 - On peut activer (ON) ou désactiver (OFF) l'entrée Flux (haute tension) connectée en parallèle à la pompe de circulation

CONSIGNE 7.4ph ou 750mV

- Sélection avec la touche  et programmer avec 
- On peut modifier la valeur de 0 à 14 pH ou de 0 à +1000 mV pour la mesure du potentiel Rédox.



PRODUIT DOSE ACIDE

- Sélection avec la touche  et programmer avec 
- On peut le modifier pour dosages Acides ou Alcalins ou High (haut) ou Low (bas) pour le potentiel Rédox.



OFA OFF

- Sélection avec la touche  et programmer avec 
- On peut modifier le temps OFA (minutes), temps de surdosage



CALIBRAGE 7/4pH ou 465mV

- Sélection avec la touche  et programmer avec 
- On peut modifier la séquence de calibration pour 2 points (7 et 4 pH), pour 1 point uniquement 7pH ou désactiver la fonction ; pour la mesure du potentiel Rédox, le choix est entre 465 mV et fonction désactivée

CORRECTION TEMP MAN 25°C (uniquement pour la mesure du pH)

- Sélection avec la touche  et programmer avec 
- On peut programmer la valeur de température manuelle (uniquement pour la mesure du pH)
- Enregistrer puis quitter le menu Programme avec la touche ESC.

EXIT

- Sélection avec la touche  et programmer avec  Sauvegarder ou ne sauvegardons pas

AMORÇAGE







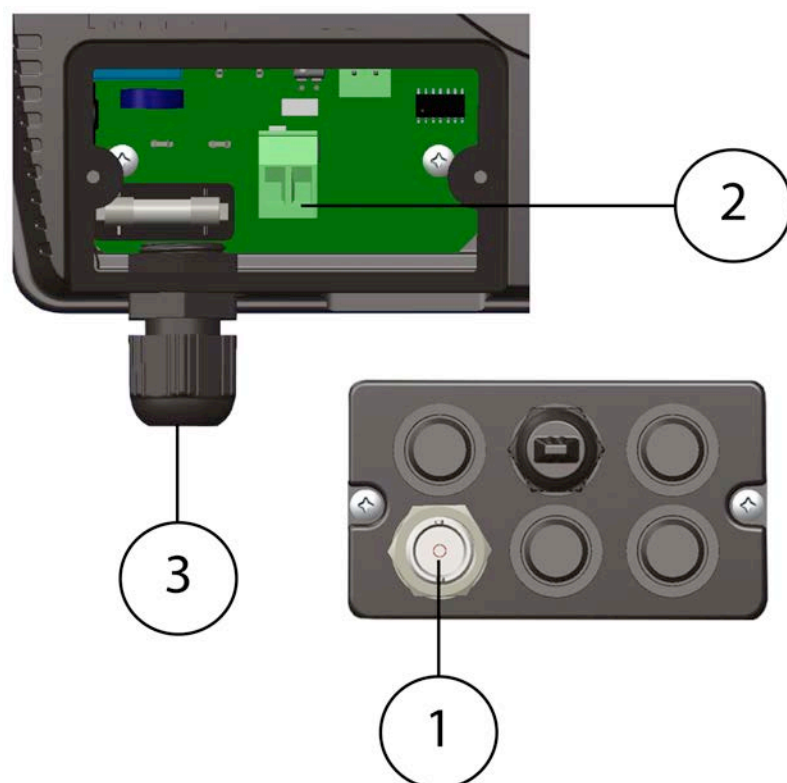

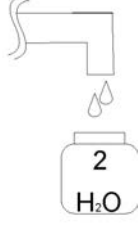

- Pour la Fonction amorçage en manuel, maintenir la touche  pendant 3 secondes

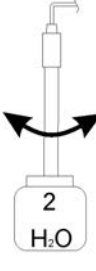
Connexion des câbles:

- 1) Entrée sonde pH ou Redox
- 2) Entrée Débit, débit pompe de recirculation (signal électrique 230 Vc.a.)
- 3) Alimentation 230 Vc.a. 50Hz / 60Hz.

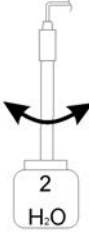

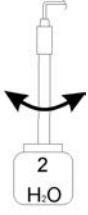
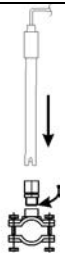





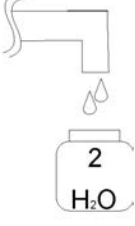

Calibrage Sonde pH

 1	 2	 Laver la sonde 3
 Maintenir la sonde dans la solution tampon 4	Calibrage Appuyer sur la touche  pendant 3 secondes 5	7pH Presser CAL  Le calibrage dure une minute. Patienter 60s 6
7pH Qualite' 100% Qualité de la sonde 7	 Laver la sonde 8	 Maintenir la sonde dans la solution tampon 9
4pH Presser CAL  Le calibrage dure une minute. Patienter 60s 10	4pH Qualite' 100% Qualité de la sonde 11	 Laver la sonde 12
 13	Appuyer sur la touche  pour quitter et enregistrer les données 14	État Normal de mesure et contrôle 15

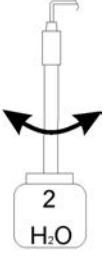
Remarque:

Si l'on programme la fonction Calibrage = 7 pH, le système n'effectue le calibrage que pour le point 7 pH.

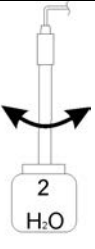
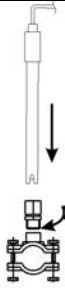
Calibrage sonde Redox

 <p>1</p>	 <p>2</p>	 <p>3 Laver la sonde</p>
 <p>Mantenere la sonda nella soluzione tampone</p> <p>4</p>	<p>Calibrage</p> <p>Appuyer sur la touche  pendant 3 secondes</p> <p>5</p>	<p>465mv Presser CAL</p> <p></p> <p>Le calibrage dure une minute. Patienter 60s</p> <p>6</p>
<p>465mv Qualite' 100%</p> <p>Qualité de la sonde</p> <p>7</p>	 <p>Laver la sonde</p> <p>8</p>	 <p>9</p>
<p>Appuyer sur la touche  pendant 3 secondes</p> <p>10</p>	<p>État Normal de mesure et contrôle</p> <p>11</p>	

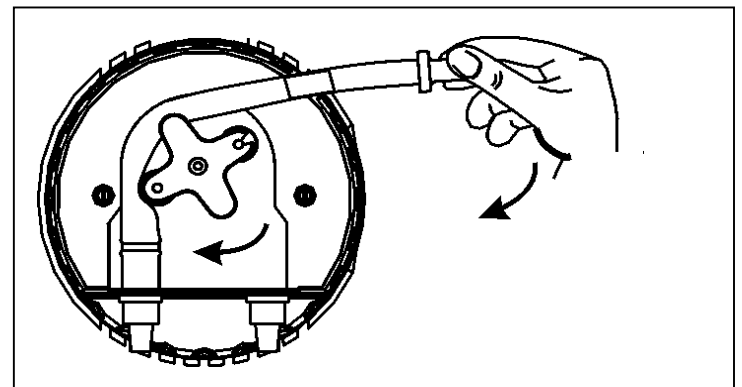
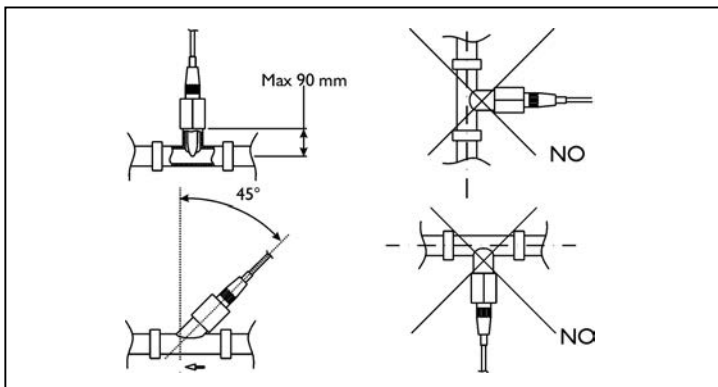
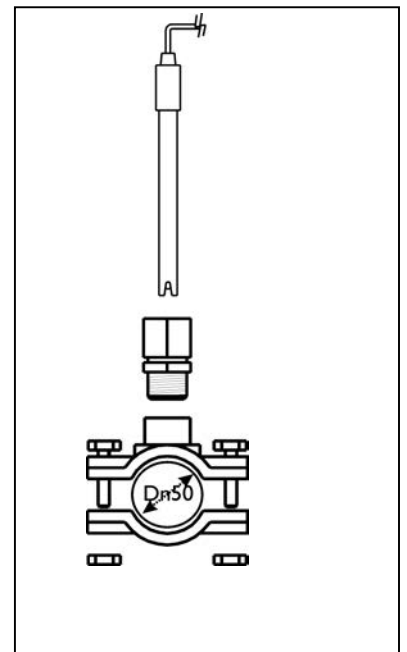
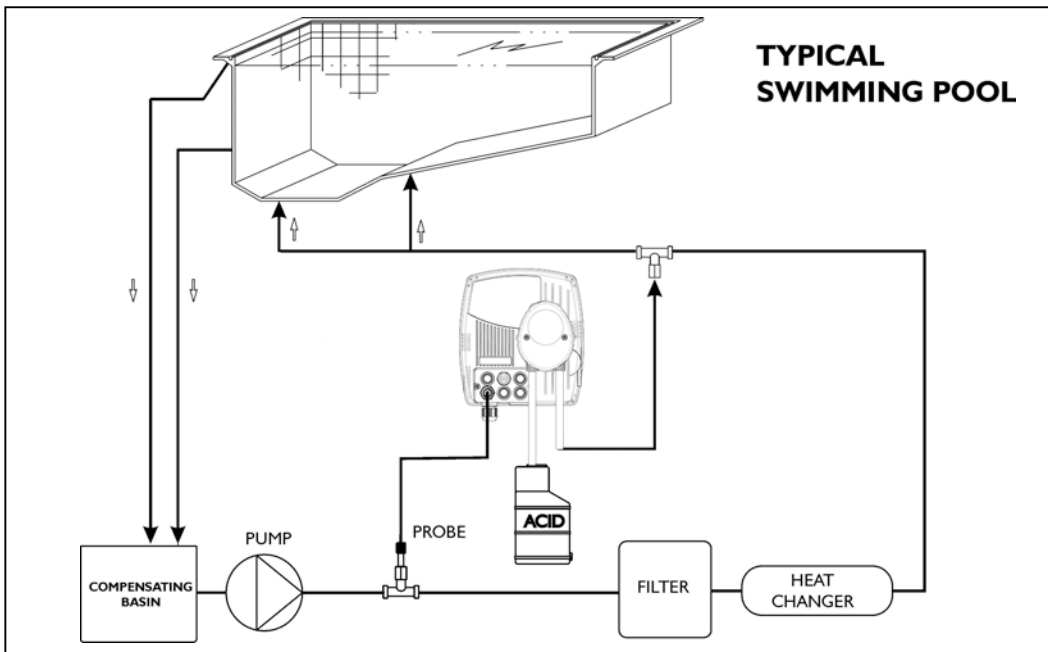





Alarme	Écran	Actions à exécuter
OFA Première Alarme (Temps >70%)	Alarme OFA	- Appuyer sur la touche Enter pour désactiver l'alarme
OFA Deuxième Alarme (Temps=100%)	STOP OFA	- Appuyer sur la touche Enter pour désactiver l'alarme
Débit eau (pompe de recirculation éteinte)	Debit	- Réactiver la pompe de circulation eau.
Erreur de système	Parameter Error	- Appuyer sur Enter pour restaurer les paramètres par défaut - Système endommagé
Fonction d'étalonnage	Erreur 7 ph Erreur 4 ph Erreur 465 mV	- Remplacer la Sonde ou la Solution tampon et répéter le calibrage.

Paramètres d'usine :

- Langue = **UK (Inglese)**
- Set Point valeur = **7,4 pH; 750mV (Rx)**
- Méthode de dosage = **Acide; Basse (Rx)**
- Temps OFA (alarme de surcharge) = **OFF**
- Calibrage = **7/4 (2 points) ; 465mV (Rx)**
- Entrée Debit = **OFF**

Pour restaurer les paramètres par défaut (Défaut), agir de la façon suivante:

- Arrêter le système Basic
- Appuyez sur les deux boutons en même temps  et  pour activer le système Basic.
- Le système affichera **Defaut Non**
- Appuyer sur la touche  pour **Defaut Oui**
- Appuyer sur la touche  pour restaurer les paramètres.

CONTROL BASIC **ASTRALPOOL**

CONTENUTO NELLA SCATOLA

- A) pH / REDOX Sistema di controllo
- B) Tubo PVC Crystal 4x6 (2 metri)
- C) Tubo Polyethylene (3 metri)
- D) Viti con tasselli ($\phi = 6$ mm)
- E) Filtro di fondo (PVC)
- F) Valvola di non ritorno in FPM (3/8" GAS)

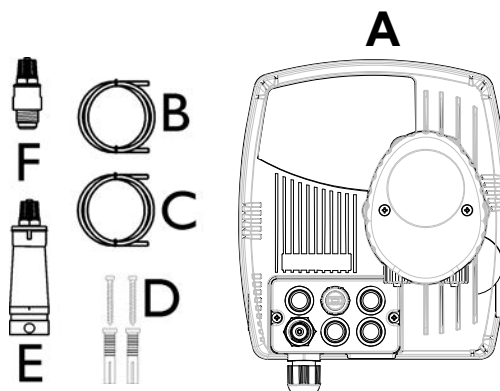

SPECIFICHE TECNICHE

Dimensioni (A – L – P)	191x155x123 mm
Peso	1 kg
Alimentazione	230 VAC
Consumo	6 W
Portata Pompa	1,5 l/h
Contro pressione Massima	1,5 bar
Pump state	Pause - Supply
Scala Misura	0 ÷ 14.0 pH; Redox 0 ÷ +1000 mV
Precisione Misura	± 0,1 pH; ±10 mV
Accuratezza Misura	± 0,02 pH; ±2 mV
Calibrazione Elettrodo	Automatica

Montaggio Parete

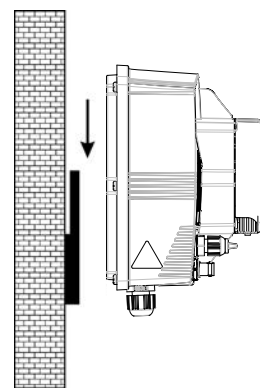

ATTENZIONE / WARNING / ATTENTION / ACHTUNG

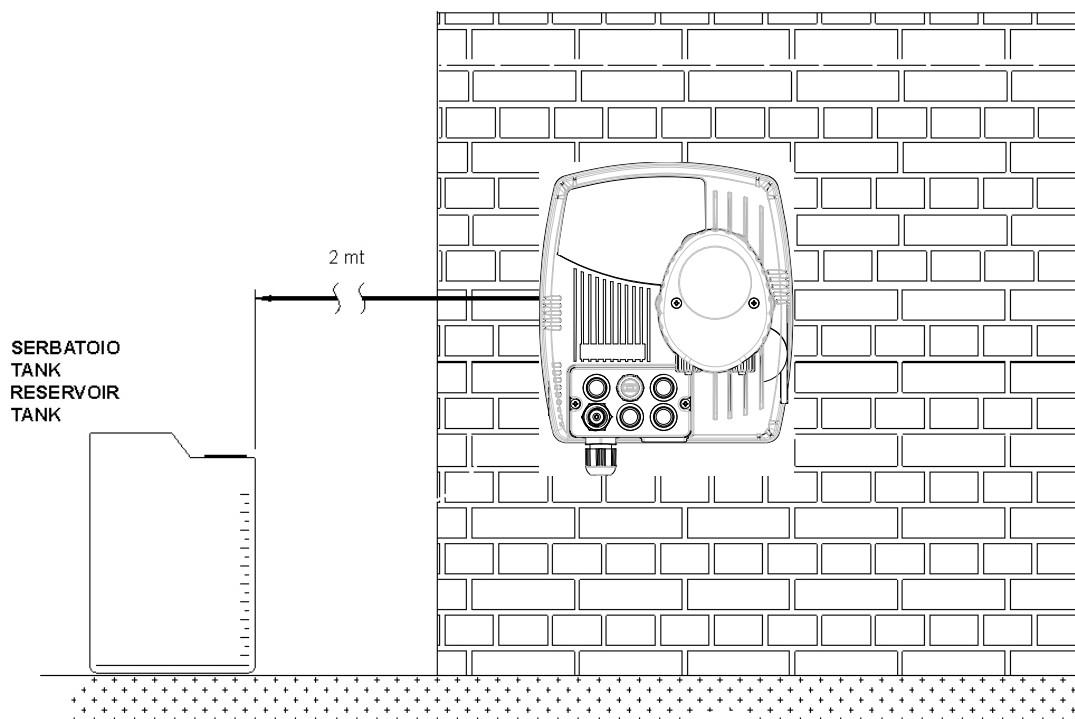





IMPOSTAZIONI

Funzione:

CALIBRAZIONE



- Premere tasto  per 3 Secondi
- Sequenza Standard calibrazione per soluzione tampone 7 e 4 pH o 465mV per il Redox

SET POINT



- Premere tasto: 
- Tenere premuto  e modificare valore con tasto 
 - **7.4ph**
 - **750mV**
- Premere tasti   (insieme) per 5 Secondi e si eseguirà il menu configurazione

MENU CONFIGURAZIONE



Premere  impostare le seguenti voci:

- **Configurazione pompa**
 - Selezionare  pH o Redox
- **Lingua**
 - Con il pulsante  si può impostare 5 lingue EN, IT, ES, DE, FR
- **Flusso**
 - Selezionare con il tasto 
 - Si può abilitare (ON) or disabilitare (OFF) l'ingresso Flusso (alta tensione) collegato in parallelo alla pompa di ricircolo



SETPOINT 7.4ph o 750mV

- Selezionare con il tasto  e impostare con 
- Si può modificare il valore da 0 a 14 pH oppure da 0 a +1000 mV per misura Redox.



TIPO SETPOINT ACIDO

- Selezionare con il tasto  e impostare con 
- Si può modificare per dosaggi Acidi o Alcalini oppure Alto o Basso per Redox.



TEMPO OFA OFF

- Selezionare con il tasto  e impostare con 
- Si può modificare il tempo (minuti) di OFA tempo di savra dosaggio



CALIBRAZIONE 7/4pH o 465mV

- Selezionare con il tasto  e impostare con 
- Si può modificare la sequenza di calibrazione per 2 punti (7 and 4 pH), oppure 1 punto solo 7pH o funzione disabilitata; per il Redox abbiamo 465 mV o funzione disabilitata.

TEMPERATURA MAN 25°C (Solo per la misura del pH)

- Selezionare con il tasto  e impostare con 
- Impostare il valore di temperatura manuale (Solo per la misura del pH)
- Salvare ed uscire dal menù Programma con il tasto ESC.

USCITA

- Selezionare con il tasto  e impostare con  Salva oppure Non Salvare

ADDESCAMENTO







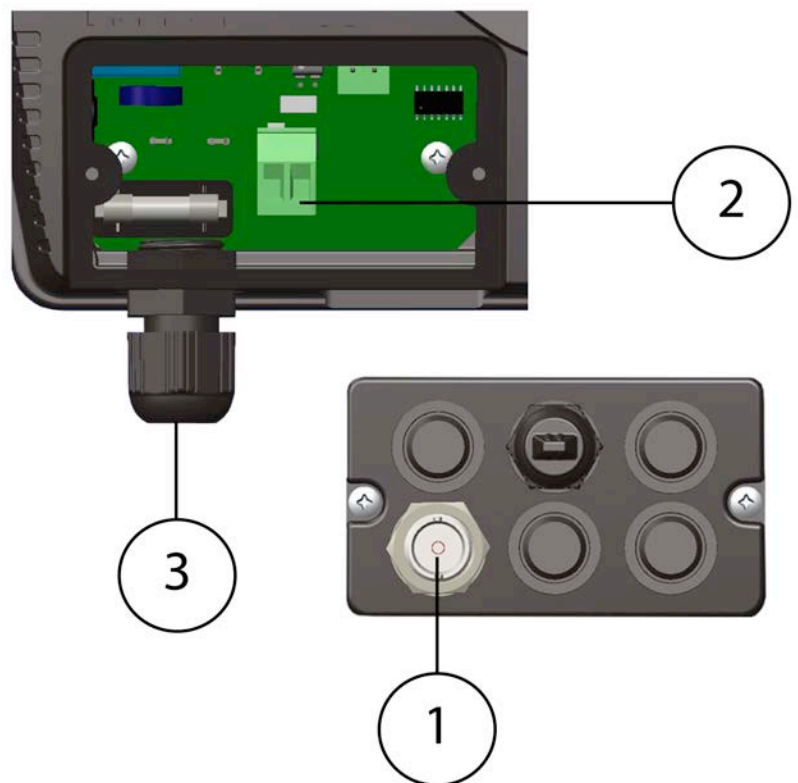

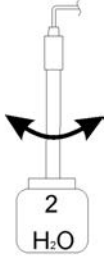

- Funzione adescamento manuale tenere premuto il tasto  per 3 secondi

Connessione Cavi:

- 1) Ingresso sonda pH or Redox
- 2) Ingresso Flusso, flusso pompa di ricircolo (segnale elettrico 230 Vac)
- 3) Alimentazione 230 Vac 50Hz / 60Hz.

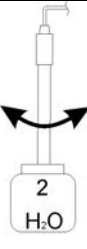

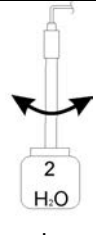
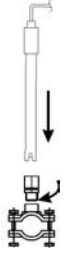





Calibrazione Sonda pH

<p style="text-align: center;"> 2 H₂O</p> <p>1</p>	<p style="text-align: center;"></p> <p>2</p>	<p style="text-align: center;"> 2 H₂O</p> <p>Lavare la sonda</p> <p>3</p>
<p style="text-align: center;"> 1 7 pH</p> <p>Mantenere la sonda nella soluzione tampone</p> <p>4</p>	<p style="text-align: center;">Calibrazione</p> <p style="text-align: center;"></p> <p>Premere tasto  per 3 Secondi</p> <p>5</p>	<p style="text-align: center;">7pH Premere CAL</p> <p style="text-align: center;"></p> <p>La calibrazione dura un minuto Attendere 60s</p> <p>6</p>
<p style="text-align: center;">7pH Qualità 100%</p> <p style="text-align: center;">Qualità sonda</p> <p>7</p>	<p style="text-align: center;"> 2 H₂O</p> <p>Lavare la sonda</p> <p>8</p>	<p style="text-align: center;"> 3 4 pH</p> <p>Mantenere la sonda nella soluzione tampone</p> <p>9</p>
<p style="text-align: center;">4pH Premere CAL</p> <p style="text-align: center;"></p> <p>La calibrazione dura un minuto Attendere 60s</p> <p>10</p>	<p style="text-align: center;">4pH Qualità 100%</p> <p style="text-align: center;">Qualità sonda</p> <p>11</p>	<p style="text-align: center;"> 2 H₂O</p> <p>Lavare la sonda</p> <p>12</p>
<p style="text-align: center;"></p> <p>13</p>	<p style="text-align: center;"></p> <p>Premere il tasto  per uscire e salvare i dati</p> <p>14</p>	<p style="text-align: center;">Stato Normale di misura e controllo</p> <p>15</p>

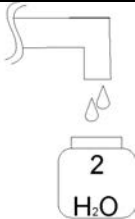
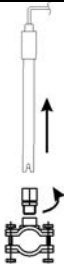
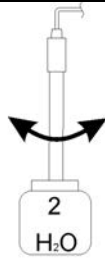
Nota:

Se impostiamo la funzione Calibrazione = 7 pH il sistema eseguirà la calibrazione soltanto per il punto 7 pH.

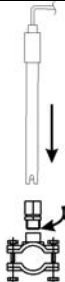
Calibrazione sonda Redox

 <p>1</p>	 <p>2</p>	 <p>Lavare la sonda</p> <p>3</p>
 <p>Mantenere la sonda nella soluzione tampone</p> <p>4</p>	<p>Calibrazione</p> <p>Premere il tasto  3 Secondi</p> <p>5</p>	<p>465mv Premere CAL</p> <p></p> <p>La calibrazione dura un minuto</p> <p>Attendere 60s</p> <p>6</p>
<p>465mv Qualità 100%</p> <p>Qualità Sonda</p> <p>7</p>	 <p>Lavare la sonda</p> <p>8</p>	 <p>9</p>
<p>Premere il tasto  3 Secondi</p> <p>10</p>	<p>Normale Stato di misura e controllo</p> <p>11</p>	

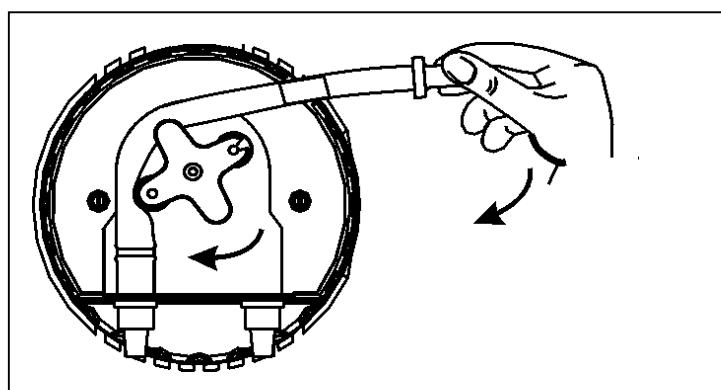
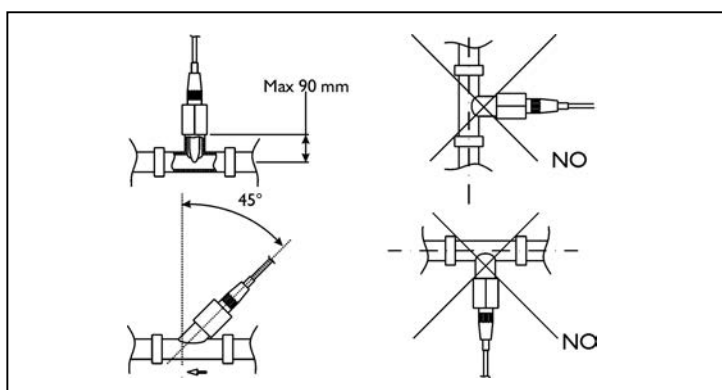
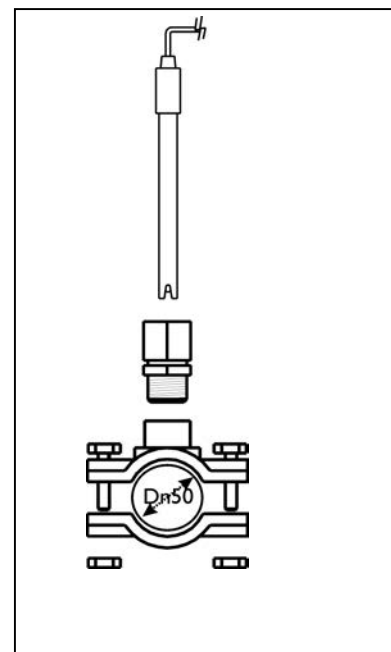
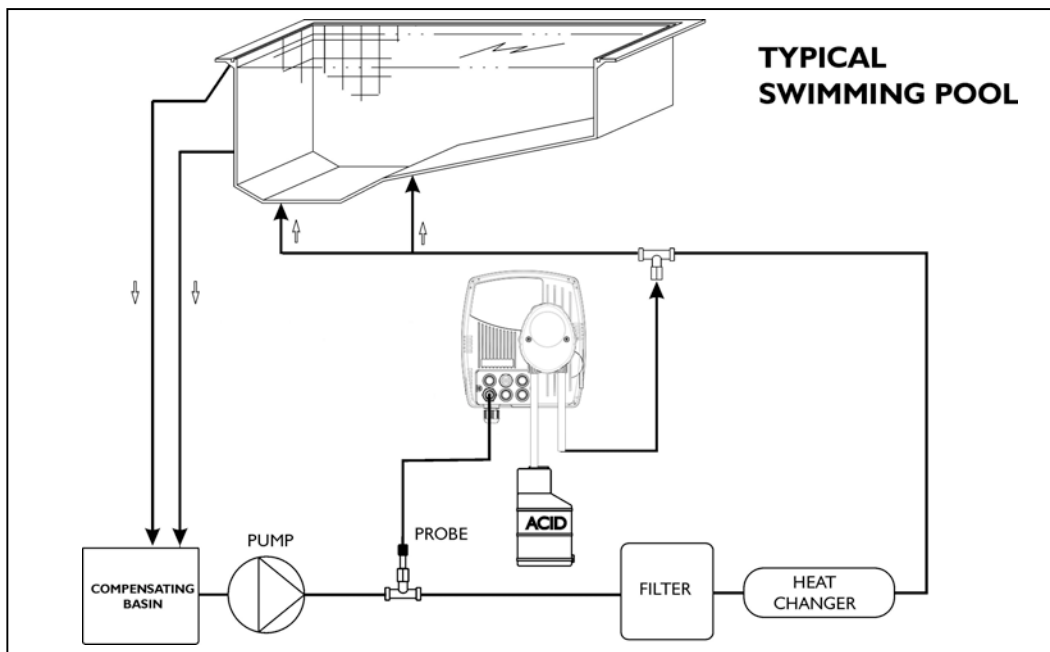





Allarme	Display	Azioni da fare
OFA Primo Allarme (Tempo >70%)	Allarme OFA	- Premere il tasto Enter per eliminare l'allarme
OFA Secondo Allarme (Tempo=100%)	Stop OFA	- Premere il tasto Enter per eliminare l'allarme
Flusso acqua (Pompa di ricircolo spenta)	Flusso	- Ripristinare pompa di ricircolo acqua.
Errore di Sistema	Parameter Error	- Premere Enter per ripristinare i parametri di fabbrica - Sistema Rotto
Funzione di Calibrazione	Errore 7ph Errore 4ph Errore 465mV	- Sostituire Sonda o Soluzione tampone e ripetere la calibrazione.

Parametri di Fabbrica:

- Lingua = **UK (Inglese)**
- Set Point valore = **7,4 pH; 750mV (Rx)**
- Metodo di Dosaggio = **Acido; Basso (Rx)**
- Tempo OFA = **OFF**
- Calibrazione = **7/4 (2 punti); 465mV (Rx)**
- Ingresso Flusso = **OFF**

Per ripristinare i parametri di fabbrica (Default) eseguire i seguenti passi:

- Spegnere il sistema Basic
- Mantenere premuto i tasti contemporaneamente  e  per accendere il sistema Basic.
- Il Sistema visualizzerà **Default No**
- Premere il tasto  per **Default Yes**
- Premere il tasto  per ripristinare i parametri.